

Article number: 03550040

Description: Fluro hydraulic rod end FPR 40S

## Measures

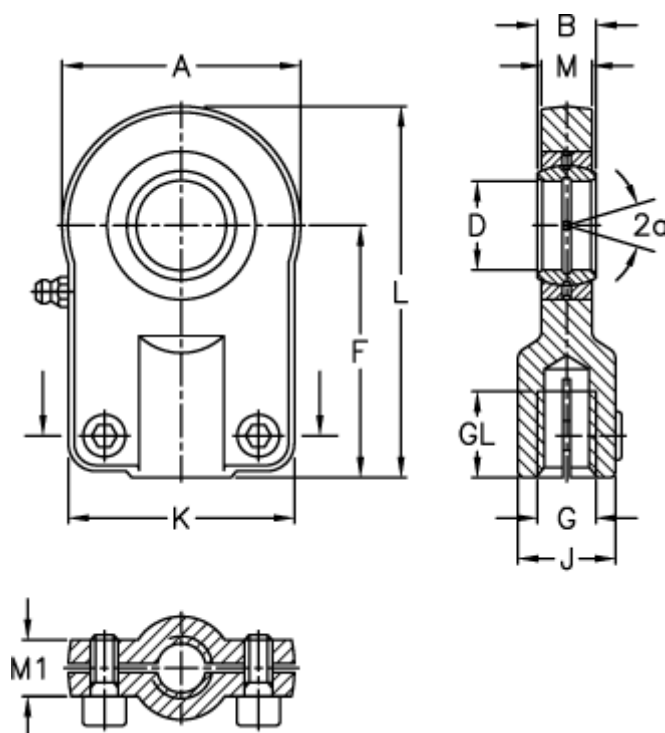

A	= 100	J	= 45
a (degrees)	= 7	K	= 90
B	= 28	L	= 155
D	= 40	M	= 23
Dynamic load C (kN)	= 100	M1	= 23
F	= 105	Static load C0 (kN)	= 156
g	= M27x2	Torque (N m)	= 49
GL	= 37	Weight	= 2300